

TACMINA

Motor-Driven Metering Pumps

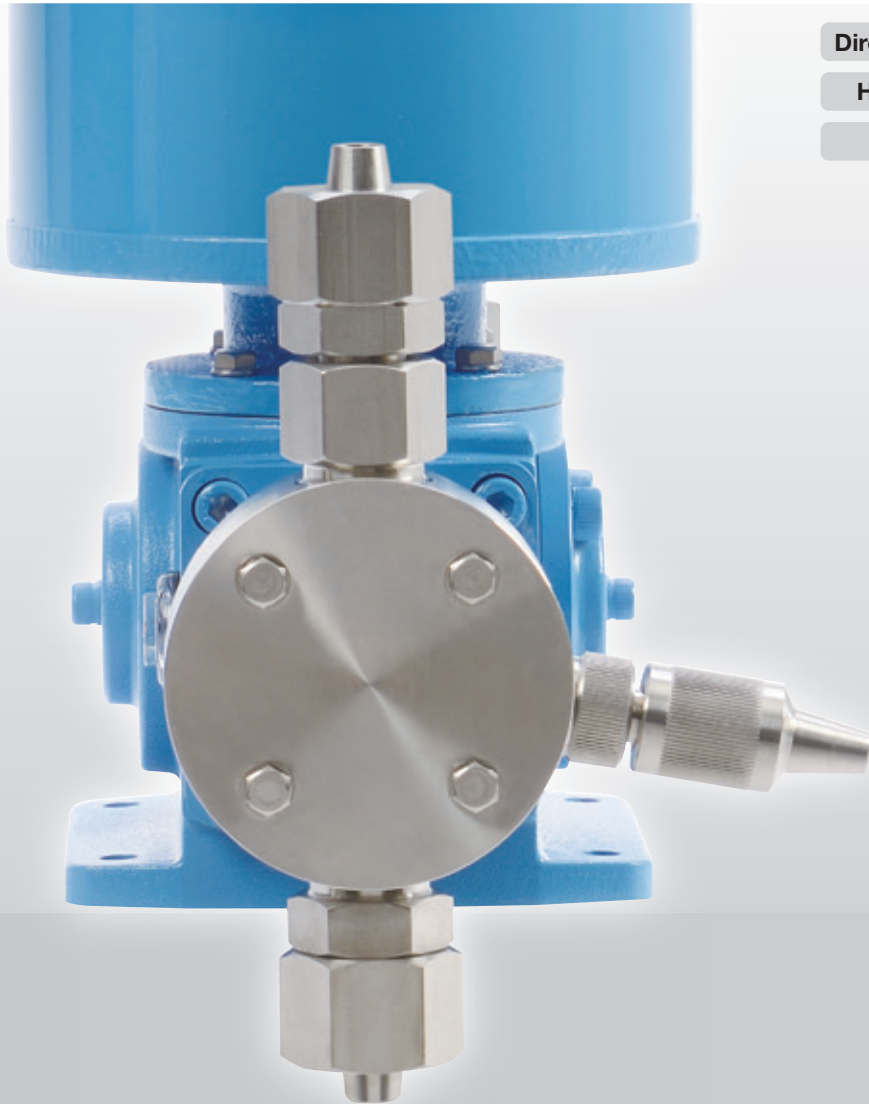

Direct-Driven Diaphragm Metering Pumps

Hydraulic Diaphragm Metering Pumps

Plunger Metering Pumps

From Water Treatment to Advanced Processes and Sanitary Processes

High-accuracy and high-functionality technologies for pumps are the research and development themes that we have been pursuing for over half a century. Our pumps feature excellent liquid transfer accuracy, as well as combining maintainability and durability, and they can be used in a wide variety of fields and applications such as water/waste water treatment, advance processes, and sanitary processes.



Direct-Driven Diaphragm Metering Pumps

For production processes and water/waste water treatment processes



Hydraulic Diaphragm Metering Pumps

For metered injections in chemical plants

We Deliver Peace of Mind and Reliability for Metered Injection of Various Fluids

INDEX

■ Features	3
■ Configuration	4
■ Application Examples	5
■ Lineup	7
■ Direct-Driven Diaphragm Metering Pumps	9
■ Hydraulic Diaphragm Metering Pumps	11
■ Plunger Metering Pumps	13
■ External Dimensions	15
■ Options/Related Products	17
■ Recommended Piping Example	18



Plunger Metering Pumps

For high-pressure metered injection of boiler chemicals

Basic Metering Pumps that Maximizes "Ease of Use"

Pumps equipped with "ease of use", where the desires of our customers are reflected in the basic functions.

General-purpose Motor Included as Standard

Various general-purpose flange motors are installed. Pumps can also be shipped without a motor attached so that users can mount their own motors.

* Models with a 0.4 kW or higher motor only

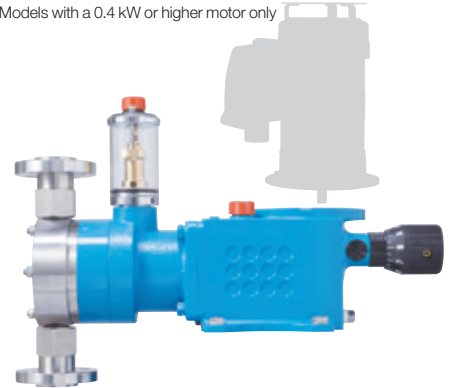

Easy-to-operate Flow Rate Adjusting Dial

The flow rate adjusting dial has been made large so as to be more visible and easier to handle. Its dial scale is also made of resin, making it resistant to corrosive liquids, and can be replaced in a simple one-touch operation.



Drain Cock with Pipe Thread

The drain hole is Rc 3/8. External piping can be connected to this hole, preventing the environment from being contaminated during oil replacement. This small but important feature is a direct result of valuable user feedback.



Detailed New Design

We have improved the design of pump details so that Z series pumps have longer lasting appeal. Chamfered corners on the casing and curved lines on the mounting base also have resulted in a lighter pump weight.



* Models with a 0.4 kW or higher motor only.



Proprietary Simple Mechanism

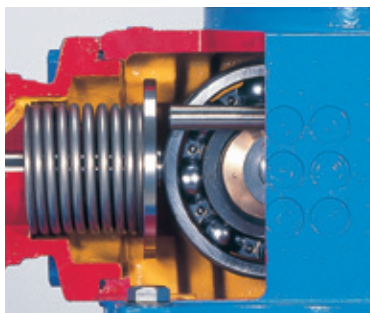

Simple with almost no replacement parts, which leads to reductions in maintenance time.

Motor attachment direction

The motor attachment direction can be selected from the vertical type "X" or the horizontal type "Y" according to the space in the pump installation location.

* Some models only available in vertical type.



Motor attachment direction: Vertical type "X"

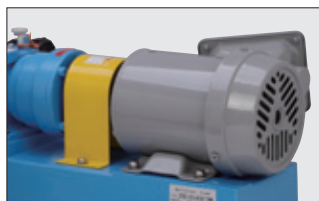

Motor attachment direction: Horizontal type "Y"

Number of pump heads

Pulsation can be reduced by increasing the number of pump heads to 2 couplings or 3 couplings. The discharge volume also increases by the number of pump heads.

* We also offer Smoothflow diaphragm pumps with no pulsation.



Number of pump heads: 1 coupling

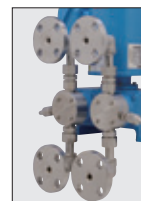

Number of pump heads: 2 couplings

Configurations that can Handle Diverse Needs

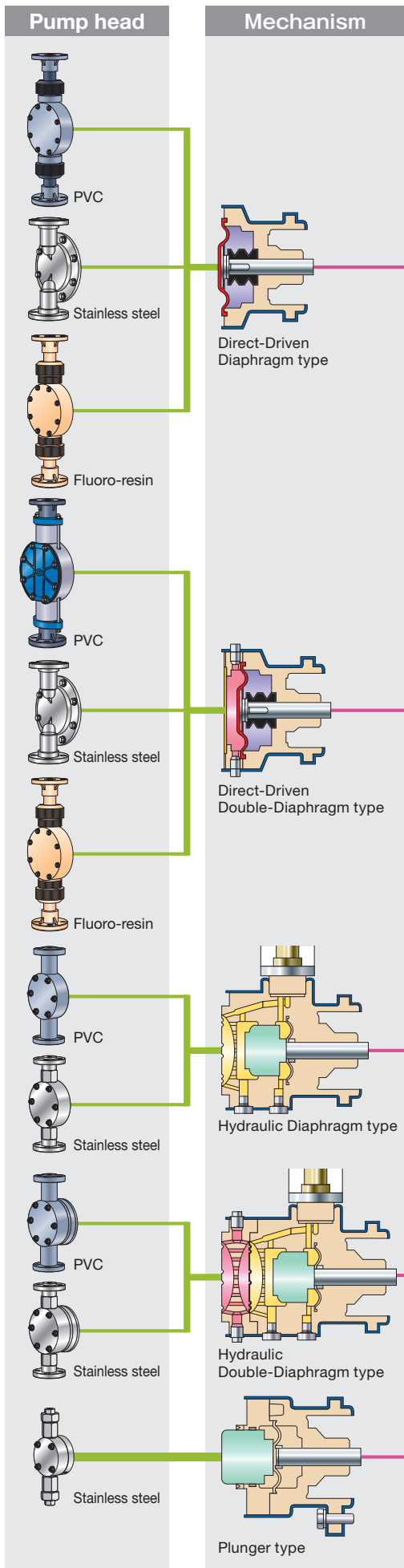

We have a lineup of motors that includes increased-safety/pressure-resistant explosion-proof motors. We offer five types of pump mechanisms. There are two types of control variations: inverter control and electric servo. We also have a lineup of special materials (titanium, hastelloy) for the liquid end materials that can handle various types of chemicals.

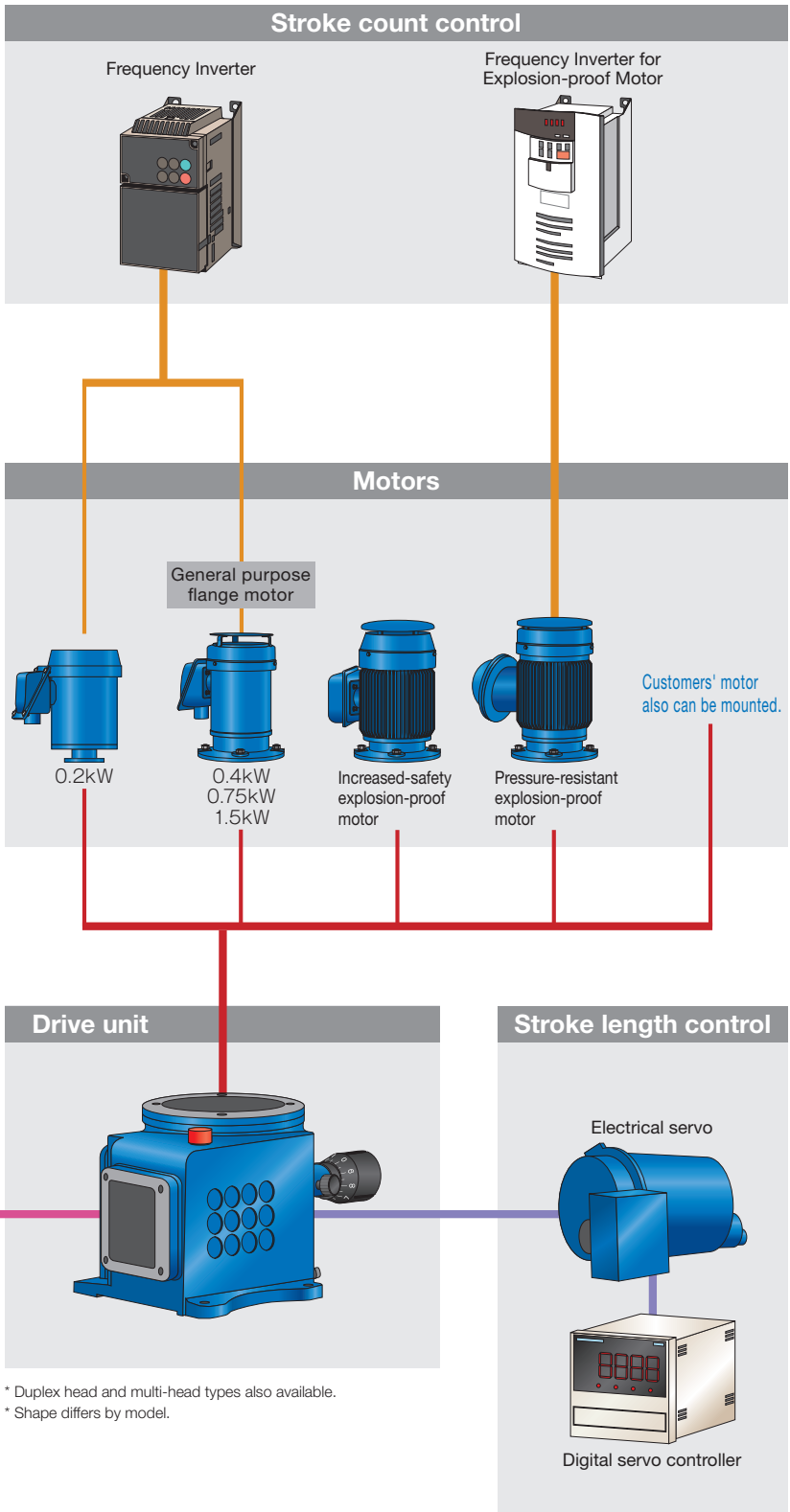

* Duplex head and multi-head types also available.
* Shape differs by model.

Application Examples

Material Supply

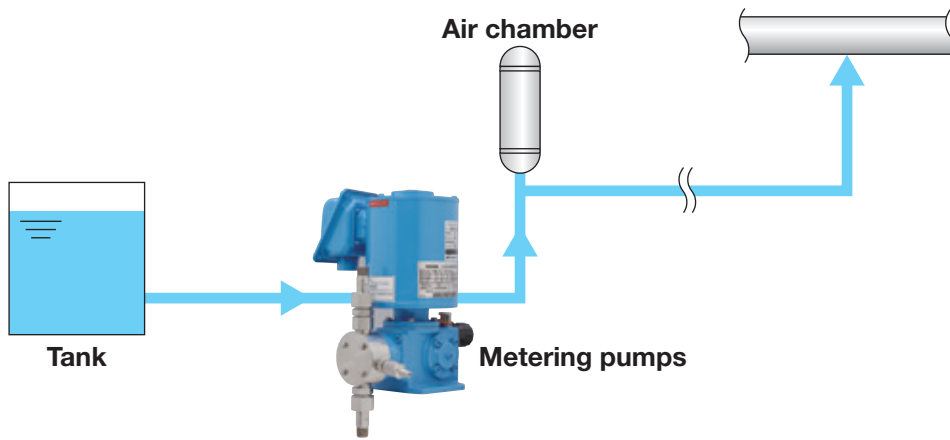

Preparation / Mixing

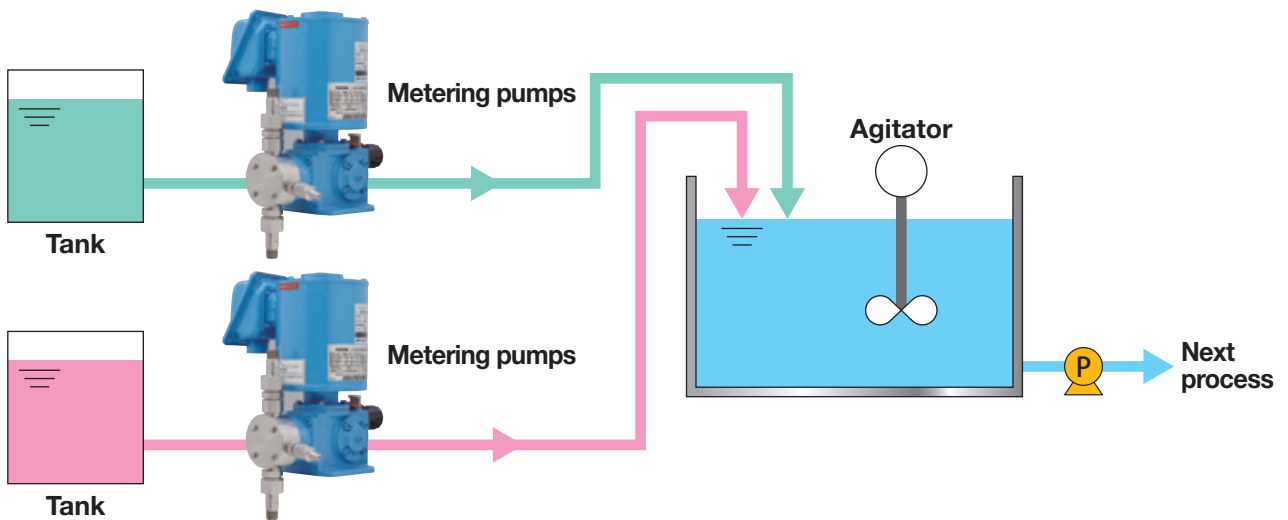

Temperature Regulation

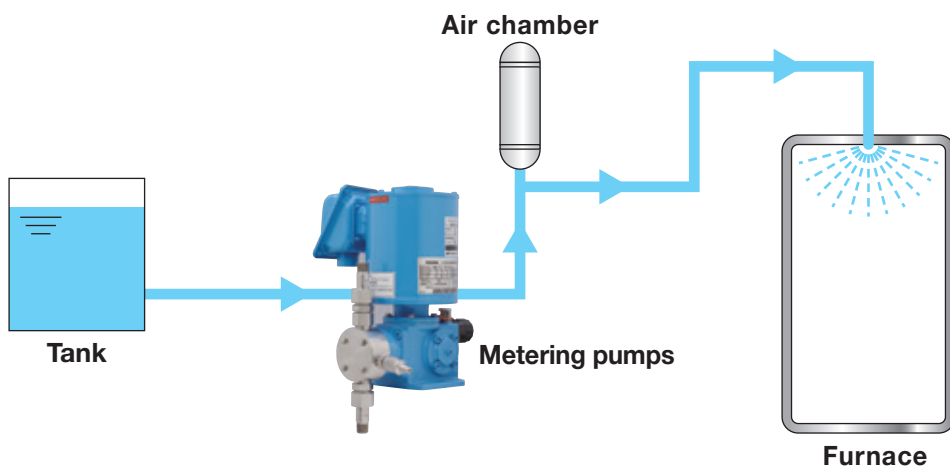

Waste Water

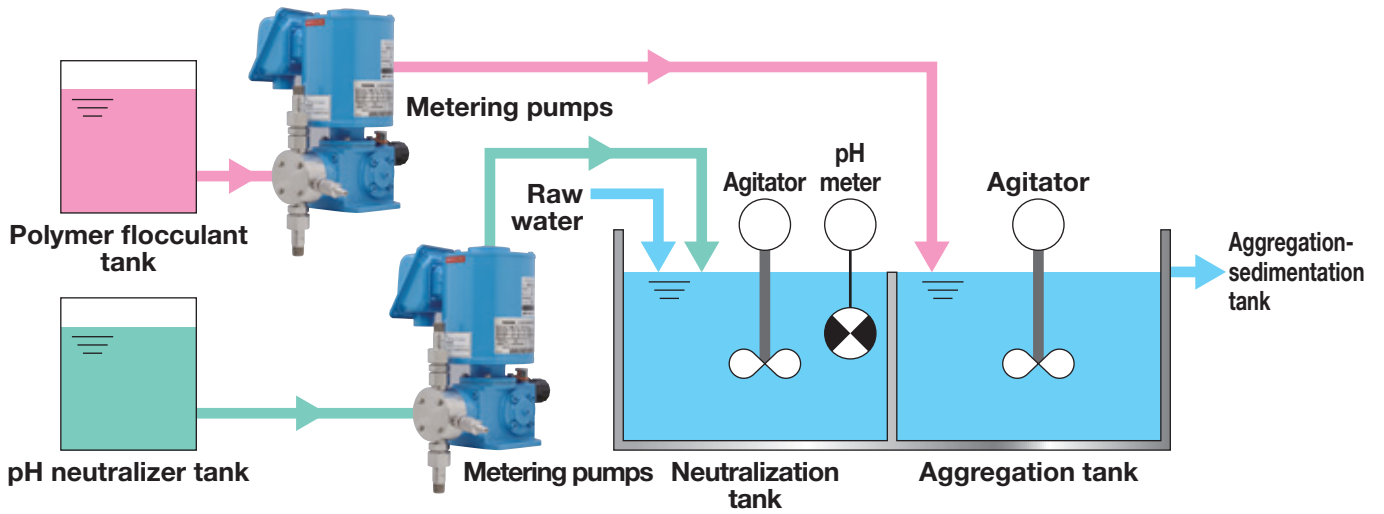

Boiler

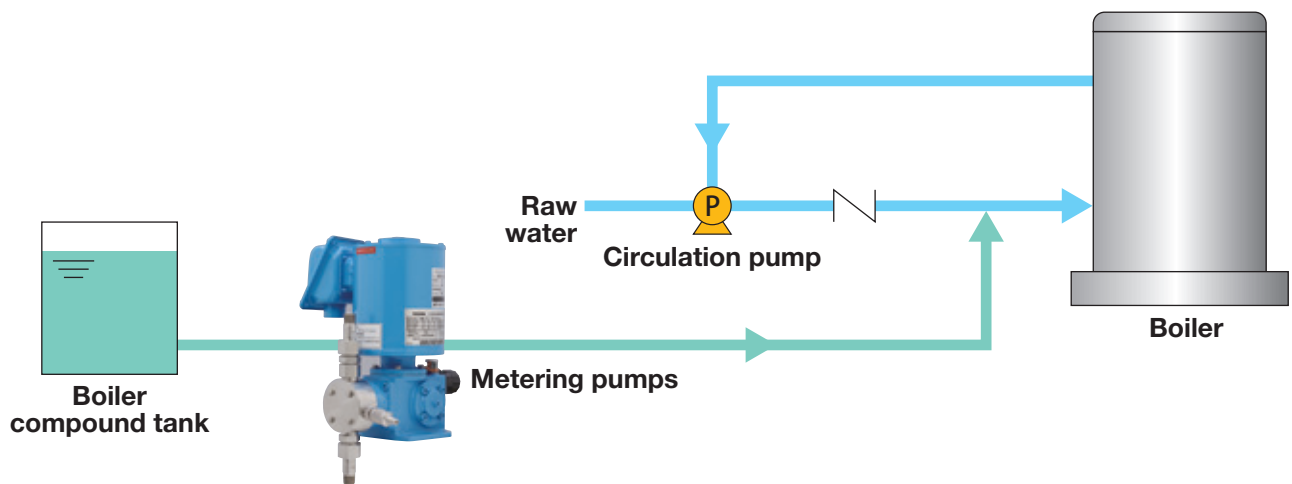

Air Conditioning

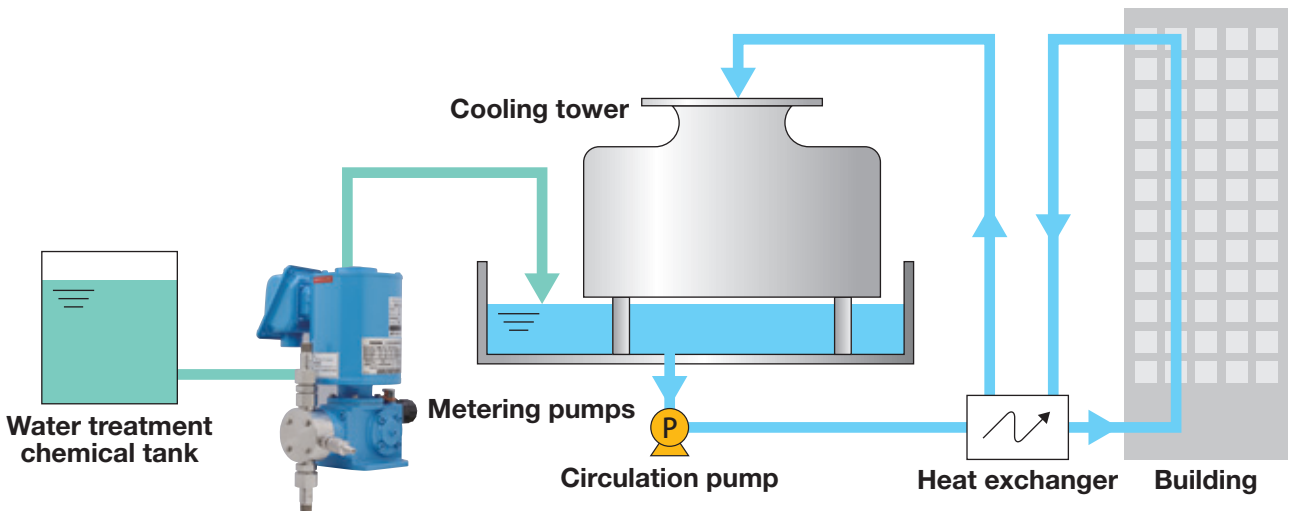

Lineup

Direct-Driven Diaphragm type (FXD·FYD) Double-Diaphragm type (FXW·FYW)

- Highly corrosion-resistant. Operable in severe operating environments.
- Simple mechanism facilitates maintenance.
- High corrosion-resistant molded diaphragm used.
- Operable at a wide range of sites ranging from water treatment through to manufacturing processes.



Hydraulic Diaphragm type (FXM·FYM) Double-Diaphragm type (FXMW·FYMW)

- Integrated relief mechanism prevents pump malfunctions and accidents to ensure safe and secure on-site operation.
- High-precision injection achieves stable quality on production lines.
- High corrosion-resistant molded diaphragm used.
- Transfer of liquids containing slurry and hazardous liquids (e.g. liquids that change by contact with air).
- High-pressure injection possible.



Plunger (FXP·FYP)

- Capable of high-accuracy, high-pressure injection by adopting a 2-stage valve seat.
- High-durability and simple maintenance.
- High-durability seal components further increase service life.
- Optimal for high-accuracy, high-pressure injection of boiler chemicals.



Pump head structure

Direct-Driven Diaphragm type

Mechanism The rotating motion of the motor is converted to reciprocating motion by the eccentric mechanism, and this reciprocating motion is transmitted to the diaphragm to transfer the fluid at a constant rate.

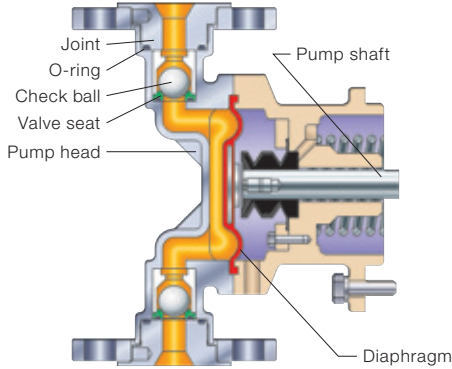

Direct-Driven Double-Diaphragm type

Mechanism The liquid is transferred by conveying the force of the drive diaphragm through the intermediate chamber to the front diaphragm. This is suited to the transfer of strong acids, strong alkali, and organic solvents with a high degree of penetration.

For durability and safety

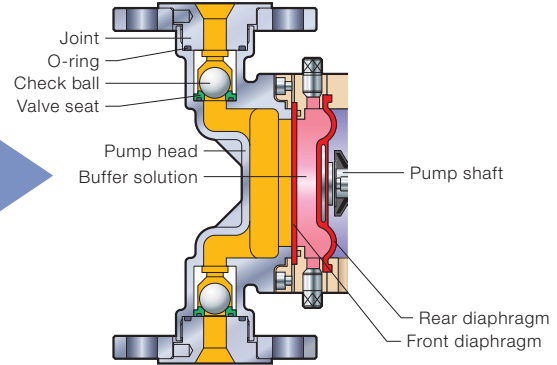

Pump head structure

Hydraulic Diaphragm type

Mechanism Liquid is transferred by conveying the force of the plunger through the hydraulic chamber to the diaphragm. High-accuracy liquid transfer makes this type suitable for high-pressure transfers.

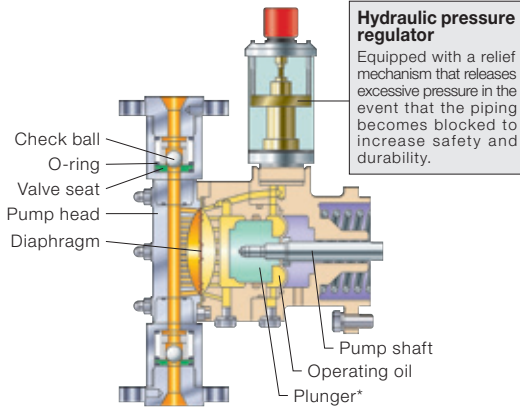

For durability and safety

Hydraulic Double-Diaphragm type

Mechanism The liquid is transferred by conveying the force of the plunger through the hydraulic chamber/intermediate chamber to the diaphragm. There is no wall in the pump chamber, so this type is suited to high-viscosity liquids and liquids containing slurries, as well as organic solvents with strong permeability.

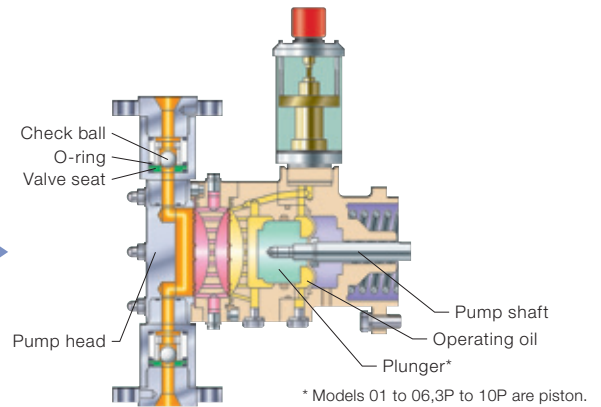

Pump head structure

Plunger type

Mechanism The liquid is suctioned and pumped by the reciprocating motion of the plunger applying a volumetric change to the interior of the cylinder.

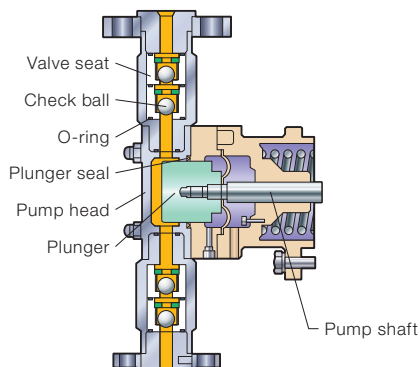

Plunger type usage precautions

- This pump cannot inject liquids containing slurries.
- Use this pump for injecting liquids with lubricating properties.
- Use this pump in environments where liquids may leak out to the air.
- Use this pump with liquids that will not crystalize when they come in contact with the air.

Direct-Driven Diaphragm type (FXD·FYD) Double-Diaphragm type (FXW·FYW)

Performance Specifications

Specification		Model	FXD·FYD·FXW·FYW										
			003	006	01	02*3	03	06	08*4	1	2	3*3	4
Max. discharge volume (50Hz/60Hz)*1	L/min	0.03/0.036	0.05/0.06 [0.06/0.072]	0.1/0.12	0.2/0.24	0.3/0.36	0.6/0.72	0.83/1	1/1.2	1.5/1.8	2.5/3	3.3/4*5	
	L/h	1.8/2.16	3/3.6 [3.6/4.32]	6/7.2	12/14.4	18/21.6	36/43.2	49.8/60	60/72	90/108	150/180	198/240	
	US G/h	0.48/0.57	0.79/0.95 [0.95/1.14]	1.6/1.9	3.2/3.8	4.8/5.7	9.5/11.4	13.1/15.8	15.8/19	23.8/28.5	39.6/47.5	52.3/63.4	
Max. discharge pressure	MPa	1*6					1*7			0.5		0.3	0.3*5
	bar	10					10			5		3	3
	psi	145					145			72.5		43.5	43.5
Stroke length*1	mm	2[4]	4			6		8		6	8	6	8
Stroke per minute (50Hz/60Hz)*1	strokes/min	53/63 [33/40]	53/63 [63/75]	105/126									
Transferrable viscosity	Standard	mPa·s 50 or less											
	High-viscosity type	mPa·s 2000 or less							mPa·s 1000 or less				
Transferrable temperature	°C	PVC: 0~40/PVDF·SUS: 0~60 (no freezing allowed)*9											
Connection type	Hose	PVC	φ4×φ9		φ6×φ11			φ12×φ18			-		
		High-viscosity type	φ12×φ18					φ19×φ26				-	
		PVDF	φ6×φ8					φ12×φ15				-	
		SUS	φ10×φ12					φ12×φ15				-	
	Flange	Standard	JIS10K15A							JIS10K25A			
		High-viscosity type	JIS10K15A			JIS10K20A			JIS10K25A				
Union*2	R 3/8												
Motor	Type	Totally enclosed fan-cooled outdoor type											
	Power supply	V/Hz	3-phase 200V (50Hz·60Hz) / 220V (60Hz)										
	Power/Number of poles	kW/P	0.2/4										
	IE code	IE1											
	Insulation class/Conduit pipe size	F / G 3/4											
	Specified current/ Locked rotor current	A	200V/50Hz: 1.4/5.85										
200V/60Hz: 1.3/5.35													
220V/60Hz: 1.4/5.89													
Weight*8	D	kg 10.5[15.5]					13[15.5]		13[15.5]		16[18.5]		
	W	kg 13[15.5]					15[18]		15[18]		19[22.5]		

*1 Values in [] are for motor attachment direction horizontal type "Y".

*2 Liquid end materials "STST" only.

*3 Motor attachment direction vertical type "X" only.

*4 Can only be selected if Liquid end materials are "VECE" or "VESE" for the direct drive diaphragm type.

*5 For the direct drive diaphragm type and diaphragm PTFE, discharge volume: 3 L/min (50 Hz), 3.6 L/min (60 Hz), discharge pressure: 0.25 MPa.

*6 Hose connection for Liquid end materials "STST": 0.5 MPa.

*7 Hose connection for Liquid end materials "STST", or "FTCT": 0.5 MPa.

*8 For Liquid end materials "STST" flange connection.

*9 The PVDF/SUS transferrable temperature for the double-diaphragm type is 0 to 80°C.

Liquid End Materials

	VECE	VESE	VTCE	VTCE	VTSF	VT6E	VT6F	STSE	STSF	STST	FTCE	FTCF	FTCT
Pump head	PVC	PVC	PVC	PVC	PVC	PVC	PVC	SCS14*1	SCS14*1	SUS304*2	PVDF	PVDF	PVDF
Diaphragm	EPDM	EPDM	PTFE	PTFE	PTFE	PTFE	PTFE	PTFE	PTFE	PTFE	PTFE	PTFE	PTFE
Check ball	Ceramic	SUS304	Ceramic	Ceramic	SUS304	SUS316	SUS316	SUS304	SUS304	SUS304	Ceramic	Ceramic	Ceramic
Joint	PVC	PVC	PVC	PVC	PVC	PVC	PVC	SUS304	SUS304	SUS304	PVDF	PVDF	PVDF
O-ring for joint	EPDM	EPDM	EPDM	Fluoro-rubber	Fluoro-rubber	EPDM	Fluoro-rubber	EPDM	Fluoro-rubber	PTFE*3	EPDM	Fluoro-rubber	(See appended table)

*1 SCS14 casting has the same composition as SUS316.

*2 Models 3P, 6, 8, 10, 10P, 15, 20, 20P, and 30 use SCS14.

*3 Models 3P, 6, 8, 10, 10P, 15, 20, 20P, and 30, use PFA/silicon rubber.

O-ring materials for FTCT type

Model	003, 006, 01, 02, 03	06, 08, 1, 2, 3, 4	3P, 6, 8, 10, 10P, 15, 20, 20P
Material	Perfluororubber	PTFE	PTFE/FEP + silicon rubber

Performance Specifications

Specification		Model	FXD·FXW								
			3P	6	8	10	10P	15	20	20P	30
Max. discharge volume (50Hz/60Hz)	L/min		3/3.6	5.6/6.8	7.2/8.6	10/12	10/12	13.3/16	17.5/21	17.5/21	25/30
	L/h		180/216	336/408	432/516	600/720	600/720	798/960	1050/1260	1050/1260	1500/1800
	US G/h		47.5/57	88.7/107.7	114/136.2	158.4/190.1	158.4/190.1	210.7/253.4	277.2/332.6	277.2/332.6	396/475.2
Max. discharge pressure	MPa		0.7	0.5		0.3	0.5		0.3	0.5	0.4
	bar		7	5		3	5		3	5	4
	psi		101.5	72.5		43.5	72.5		43.5	72.5	58
Stroke length	mm		10	8	10	15			20		25
Stroke per minute (50Hz/60Hz)	strokes/min		105/126			81/97		105/126			81/97
Transferrable viscosity	mPa·s		Ceramic check ball: 100 mPa·s, Stainless steel check ball: 3000 mPa·s (2000 mPa·s on the 30 type)* ²								
Transferrable temperature	°C		PVC: 0~40/PVDF·SUS: 0~60 (no freezing allowed)* ³								
Connection type	Flange		JIS10K25A			JIS10K40A				JIS10K50A	
Motor	Type		Totally enclosed fan-cooled outdoor type								
	Power supply	V/Hz	3-phase 200V (50Hz·60Hz) / 220V (60Hz)								
	Power/Number of poles	kW/P	0.4/4			0.75/4			1.5/4		
	IE code		IE1			IE3					
	Insulation class/Conduit pipe size		E / G 3/4			F / G 3/4					
	Specified current/ Locked rotor current	A	200V/50Hz: 2.3/10.2			200V/50Hz: 3.5/23			200V/50Hz: 6.9/56		
		200V/60Hz: 2/9.07			200V/60Hz: 3.2/20			200V/60Hz: 6.1/44			
		220V/60Hz: 2/9.98			220V/60Hz: 3.1/22			220V/60Hz: 5.9/51			
Weight* ¹	D	kg	27	29	34	53			62	71	
	W		29	31	38	57			—		

*¹ For Liquid end materials "STST". *² For polymer coagulants. Please contact us for other chemicals.

*³ The PVDF/SUS transferrable temperature for the double-diaphragm type is 0 to 80°C.

Model Code

F X D 1 - 1 - STST - F W S

1 2 3 4 5 6 7 8 9 10 11

1 Series name	2 Drive box type	3 Type	4 Number of pump heads* ¹	5 Model* ²	6 Relief valve* ³	7 Pressure specification* ⁴	8 Liquid end Materials* ⁵	9 Connection type* ⁶	10 Valve structure* ⁷	11 General specification
F : Standard SF : Sanitary	X : Vertical type Y : Horizontal type	D : Direct-drive diaphragm W : Direct-drive double diaphragm	1 : 1 head 2 : Duplex	003 006 01 02 03 06 08 1 2 3 4 6 8 10 15 20 30	Blank : w/o relief valve R : w/ relief valve	Blank : Standard P : High-Pressure type	VECE VESE VTCE VTCF VTSF VT6E VT6F STSE STSF STST FTCE FTCF FTCT VTCE VTCF VTSF VT6E VT6F STSE STSF STST FTCT	H : Hose F : Flange U : Union	W : Standard V : High-viscosity type	S : Standard X : Special

*¹ Pumps with 3 or more heads can also be manufactured. Contact TACMINA for details.

*² For Model 003, if **3** Type is Direct-driven double-diaphragm, then **2** Drive box type is Horizontal only. For Models 02 and 3, **2** Drive box type is Vertical only. For Model 08, if **3** Type is Direct-driven diaphragm, **8** Liquid end material is VECE or VESE. For Models 20 and 30, **3** Type is Direct-driven diaphragm only.

*³ Models with relief valves are coded as: 003 through 4 for **5** and Standard for **7**.

*⁴ High-pressure models are coded as: Direct-driven diaphragm for **3** and 3, 10, or 20 for **5**, or Direct-driven double-diaphragm for **3** and 3 or 10 for **5**. **8** Liquid end material is selectable from VTCE, VTCF, VT6E, VT6F, STSE, STSF, STST, and FTCT.

*⁵ If the liquid end material is VECE, **5** Model can be any model from 003 through 4. If the liquid end material is VESE or VTSF, **5** Model can be any model from 003 through 03 and

10 Valve structure is High viscosity type. If the liquid end material is FTCE or FTCF, **5** Model can be any model from 003 through 4 and **6** Relief valve is "w/o relief valve."

If the liquid end material is FTCT, when **3** is Direct-driven diaphragm, 30 is not selectable for **5**. If the liquid end material is VTCE, VT6E, VT6F, STSE, or STSF, when **3** Model is 3, then

7 Pressure specification is always High-pressure type; otherwise **3** Model can be any model from 6 through 30.

*⁶ If the connection type is Union, **5** Model can be any model from 003 ~ 2 and **8** Liquid end material is STST. If the connection type is Hose, **5** Model can be any model from 003 through 2 and **8** Liquid end material is VECE, VTCF, VESE, VTSF, STST, FTCE, FTCF, or FTCT.

*⁷ If the valve structure is High-viscosity type, **8** Liquid end material is VESE or VTSF.

Hydraulic Diaphragm type (FXM·FYM) Double-Diaphragm type (FXMW·FYMW)

Performance Specifications

Specification		Model	FXM·FYM·FXMW·FYMW			FXM·FXMW		
			01	02	06	08	1	3
Max. discharge volume (50Hz/60Hz)	L/min		0.097/0.115	0.195/0.235	0.5/0.6	0.67/0.8	1.37/1.65	2.7/3.2
	L/h		5.82/6.9	11.7/14.1	30/36	40.2/48	82.2/99	162/192
	US G/h		1.54/1.82	3.09/3.72	7.9/9.5	10.6/12.7	21.7/26.1	42.8/50.7
Max. discharge pressure*1	MPa		1 [2.5]		1 [2]	1 [1.6]		1 [1.2]
	bar		10 [25]		10 [20]	10 [16]		10 [12]
	psi		145 [362.6]		145 [290.1]	145 [232.1]		145 [174]
Stroke length	mm		8			15		
Stroke per minute (50Hz/60Hz)	strokes/min		105/126			81/97		
Transferrable viscosity	mPa·s		50 or less					
Transferrable temperature	°C		PVC:0~40/PVDF·SUS:0~80 (no freezing allowed)					
Connection type	Flange	PVC/PVDF	JIS10K15A				JIS10K20A	
		SUS*2	JIS30K15A		JIS16K15A		JIS16K20A	
	Union	PVC	VP16			-		
		PVDF/SUS	R 3/8			-		
Motor	Type		Totally enclosed fan-cooled outdoor type					
	Power supply	V/Hz	3-phase 200V (50Hz·60Hz) / 220V (60Hz)					
	Power/Number of poles	kW/P	0.2/4			0.4/4		
	IE code		IE1					
	Insulation class/Conduit pipe size		F / G 3/4			E / G 3/4		
	Specified current/ Locked rotor current	A	200V/50Hz:1.4/5.85			200V/50Hz:2.3/10.2		
200V/60Hz:1.3/5.35			200V/60Hz:2/9.07					
220V/60Hz:1.4/5.89			220V/60Hz:2/9.98					
Weight*3	M	kg	15.5 [18]			30	30	30
	MW		16 [18.5]			30	31	30

*1 Values in [] apply if the liquid end material is stainless steel.

*2 The suction-side nominal pressure is JIS10K.

*3 Values are for models using stainless steel type flange connection; values in [] are for the horizontal drive box type.

Liquid End Materials

	VTCF	STSE	STSF	STST	6T6T	FTCT
Pump head	PVC	SUS304	SUS304	SUS304	SCS14 *2	PVDF
Diaphragm	PTFE	PTFE	PTFE	PTFE	PTFE	PTFE
Check ball	Ceramic	SUS304	SUS304	SUS304	SUS316	Ceramic
Joint	PVC	SUS304	SUS304	SUS304	SUS316	PVDF
O-ring for joint	Fluoro-rubber	EPDM	Fluoro-rubber	PTFE *1	PFA/silicon rubber·PTFE *3	PTFE

*1 Models 08, 08P, 1, 1P, and 3 use PFA/silicon rubber.

*2 SCS14 casting has the same composition as SUS316.

*3 Hydraulic double-diaphragm types use PFA/silicon rubber.

Performance Specifications

Specification		Model	FXM·FXMW						
		6	10	08P	1P	3P	6P	10P	
Max. discharge volume (50Hz/60Hz)	L/min	5.5/6.5	8.5/10	0.67/0.8	1.37/1.65	2.5/3	5.5/6.5	8.5/10	
	L/h	330/390	510/600	40.2/48	82.2/99	150/180	330/390	510/600	
	US G/h	87.1/103	134.6/158.4	10.6/12.7	21.7/26.1	39.6/47.5	87.1/103	134.6/158.4	
Max. discharge pressure*1	MPa	0.7 [0.7]	0.6 [0.6]	[2.5]			[2]	[1.2]	
	bar	7 [7]	6 [6]	[25]			[20]	[12]	
	psi	101.5 [101.5]	87 [87]	[362.6]			[290.1]	[174]	
Stroke length	mm	15							
Stroke per minute (50Hz/60Hz)	strokes/min	80/97		81/97		80/97			
Transferrable viscosity	mPa·s	50 or less							
Transferrable temperature	°C	PVC: 0~40/PVDF·SUS: 0~80 (no freezing allowed)							
Connection type	Flange	PVC/PVDF	JIS10K40A		—				
		SUS*2	JIS10K40A		JIS30K15A		JIS30K20A	JIS20K40A	
	Union	PVC	—						
		PVDF/SUS	—						
Motor	Type	Totally enclosed fan-cooled outdoor type							
	Power supply	V/Hz	3-phase 200V (50Hz·60Hz) / 220V (60Hz)						
	Power/Number of poles	kW/P	1.5/4		0.4/4		1.5/4		
	IE code		IE3		IE1		IE3		
	Insulation class/Conduit pipe size		F / G 3/4		E / G 3/4		F / G 3/4		
	Specified current/ Locked rotor current	A	200V/50Hz: 6.9/56		200V/50Hz: 2.3/10.2		200V/50Hz: 6.9/56		
			200V/60Hz: 6.1/44		200V/60Hz: 2/9.07		200V/60Hz: 6.1/44		
220V/60Hz: 5.9/51			220V/60Hz: 2/9.98		220V/60Hz: 5.9/51				
Weight*3	M	kg	89	100	31		81	89	100
	MW		93	104	31	32	84	93	104

*1 Values in [] apply if the liquid end material is stainless steel.

*2 The suction-side nominal pressure is JIS10K.

*3 Values are for models using stainless steel type flange connection.

Model Code

F **X** **M** **1** - **01** **□** - **STST** - **F** **W** **S**

1 **2** **3** **4** **5** **6** **7** **8** **9** **10**

1 Series name	2 Drive box type	3 Type	4 Number of pump heads*1	5 Model*2	6 Pressure specification*3	7 Liquid end Materials	8 Connection type	9 Valve structure	10 General specification
F : Standard SF : Sanitary	X : Vertical type Y : Horizontal type	M : Hydraulic diaphragm MW : Hydraulic double-diaphragm	1 : 1 head 2 : Duplex	01 02 06	Blank : Standard	VTCF STST FTCT	F : Flange U : Union	W : Standard	S : Standard X : Special
	X : Vertical type			08 1 3	Blank : Standard P : High-Pressure type	VTCF STSE *4 STSF *4 STST *5	F : Flange		
				6 10		VTCF 6T6T			

*1 Pumps with 3 or more heads can also be manufactured. Contact TACMINA for details.

*2 For Models 08 through 10, Horizontal model can be selected for 2 Drive box type in the case of a two-head application.

*3 For high-pressure models, select 7 from among STSE, STSF, STST, and 6T6T.

*4 Liquid end materials STSE and STSF are not available when 5 Model is 3 and 6 Pressure specification is High-pressure type.

*5 If 5 Model is 3 and 6 Pressure specification is "P" High-pressure type, the selectable liquid end material is only 6T6T.

Plunger (FXP·FYP)

Performance Specifications

Specification		Model	FXP·FYP					FXP		
		0005	001	002	006	01	02	04	08	
Max. discharge volume (50Hz/60Hz)*1	L/min	0.0045/0.0055 [0.004/0.005]	0.01/0.012 [0.009/0.011]	0.023/0.028 [0.022/0.027]	0.058/0.07 [0.054/0.065]	0.12/0.14 [0.11/0.13]	0.23/0.28 [0.22/0.26]	0.35/0.42	0.68/0.82	
	L/h	0.27/0.33 [0.24/0.3]	0.6/0.72 [0.54/0.66]	1.38/1.68 [1.32/1.62]	3.48/4.2 [3.24/3.9]	7.2/8.4 [6.6/7.8]	13.8/16.8 [13.2/15.6]	21/25.2	40.8/49.2	
	US G/h	0.07/0.09 [0.06/0.08]	0.16/0.19 [0.14/0.17]	0.36/0.44 [0.35/0.43]	0.92/1.11 [0.86/1.03]	1.9/2.22 [1.74/2.06]	3.64/4.44 [3.48/4.12]	5.54/6.65	10.8/13	
Max. discharge pressure	MPa	3					2	10	5	
	bar	30					20	100	50	
	psi	435.1					290.1	1450.4	725.2	
Stroke length	mm	8					15			
Stroke per minute(50Hz/60Hz)*1	strokes/min	53/63[49/59]					81/97			
Transferrable viscosity	mPa·s	50 or less								
Transferrable temperature	°C	0~80(no freezing allowed)								
Connection type	Flange	Discharge side	-			JIS30K15A		-		
		Suction side	-			JIS10K15A		-		
	Union	R 3/8					Rc 3/8			
Motor	Type	Totally enclosed fan-cooled outdoor type								
	Power supply	V/Hz	3-phase 200V (50Hz·60Hz) /220V (60Hz)							
	Power/Number of poles	kW/P	0.2/4					0.4/4		
	IE code	IE1								
	Insulation class/Conduit pipe size	F / G 3/4								
	Specified current/ Locked rotor current	A	200V/50Hz: 1.4/5.85					200V/50Hz: 2.3/10.2		
		200V/60Hz: 1.3/5.35					200V/50Hz: 2/9.07			
		220V/60Hz: 1.4/5.89					200V/50Hz: 2/9.98			
Weight*1	Flange	kg	-		12[14.5]	13[15.5]		-		
	Union		11[13.5]			12[14.5]		21		

*1 Values in [] are for the horizontal drive box type.

Liquid End Materials

	SNSN	STSE	STSF	STST	6T6T
Pump head	SUS304	SUS304	SUS304	SUS304	SUS316
Plunger	SUS304	SUS304	SUS304	SUS304	SUS316
Check ball	SUS304	SUS304	SUS304	SUS304	SUS316
Joint	SUS304	SUS304	SUS304	SUS304	SUS316
O-ring for joint	NBR	EPDM	Fluoro-rubber	PTFE*2	PFA/silicon rubber
Plunger seal*1	NBR	PTFE/SUS301	PTFE/SUS301	PTFE*3	PTFE/Hastelloy-C

*1 For Models 0005 through 02, V-packing is used as the plunger seal.

*2 Models 04, 08, 08P, 1, and 3 use PFA/silicon rubber.

*3 Models 04, 08, 08P, 1, and 3, use PTFE/SUS301.

Performance Specifications

Specification		Model		FXP					
		1	3	08P	1P	3P	6P	10P	
Max.discharge volume (50Hz/60Hz)	L/min	1.4/1.68	2.75/3.3	0.68/0.82	1.4/1.68	2.5/3	5.5/6.5	8.5/10	
	L/h	84/100.8	165/198	40.8/49.2	84/100.8	150/180	330/390	510/600	
	US G/h	22.2/26.6	43.6/52.3	10.8/13	22.2/26.6	39.6/47.5	87.1/103	134.6/158.4	
Max.discharge pressure	MPa	2.5	1.2	7	3.5	4	2	1.2	
	bar	25	12	70	35	40	20	12	
	psi	362.6	174	1015.3	507.6	580.2	290.1	174	
Stroke length	mm	15							
Stroke per minute (50Hz/60Hz)	strokes/min	81/97				80/97			
Transferrable viscosity	mPa·s	50 or less							
Transferrable temperature	°C	0~80 (no freezing allowed)							
Connection type	Flange	Discharge side	JIS30K15A	JIS16K20A	-			JIS20K40A	
		Suction side	JIS10K15A	JIS10K20A	-			JIS10K40A	
	Union	-		Rc 3/8	Rc 1/2	Rc 1/2	-		
Motor	Type		Totally enclosed fan-cooled outdoor type						
	supply	V/Hz	3-phase 200V (50Hz·60Hz) / 220V (60Hz)						
	Power/Number of poles	kW/P	0.4/4		0.75/4		1.5/4		
	IE code		IE1		IE3				
	Insulation class/Conduit pipe size		E / G 3/4		F / G 3/4				
	Specified current/ Locked rotor current	A	200V/50Hz:2.3/10.2		200V/50Hz:3.5/23		200V/50Hz:6.9/56		
200V/50Hz:2/9.07			200V/60Hz:3.2/20		200V/60Hz:6.1/44				
200V/50Hz:2/9.98			220V/60Hz:3.1/22		220V/60Hz:5.9/51				
Weight	Flange	kg	25	-	-	-	94	97	
	Union		-	42	44	82	-		

Model Code

F **X** **P** **1** - **01** - **STST** - **F** **W** **S**

1 **2** **3** **4** **5** **6** **7** **8** **9** **10**

1 Series name	2 Drive box type	3 Type	4 Number of pump heads*1	5 Model*2	6 Pressure specification	7 Liquid end Materials	8 Connection type	9 Valve structure	10 General specification
F : Standard	X : Vertical type Y : Horizontal type	P : Plunger	1 : 1 head 2 : Duplex	0005 001 002 006 01 02	Blank : Standard	SNSN STST	F : Flange*5 U : Union	W : Standard	S : Standard X : Special
	X : Vertical type			04	Blank : Standard	STSE*3 STSF*3 STST*4	U : Union F : Flange*6 U : Union*7		
				08 1 3	Blank : Standard P : High-Pressure type				
				6 10	P : High-Pressure type	6T6T	F : Flange		

*1 Pumps with 3 or more heads can also be manufactured. Contact TACMINA for details.

*2 For Models 04 through 3, Horizontal model can be selected for 2 Drive box type in the case of a two-head application.

*3 Liquid end materials STSE and STSF are not available when 5 Model is 3 and 6 Pressure specification is High-pressure type.

*4 If 5 Model is 3 and 6 Pressure specification is High-pressure type, the selectable liquid end material is only 6T6T.

*5 Flange connection is not available when 5 Model is 0005, 001, or 002.

*6 Flange connection type models are coded as: 1 or 3 for 5 and Standard for 6.

*7 If the connection type is Union, 5 Model is 08, or 1 or 3 with High-pressure type for 6.

External Dimensions

Direct-Driven Diaphragm type

FXD

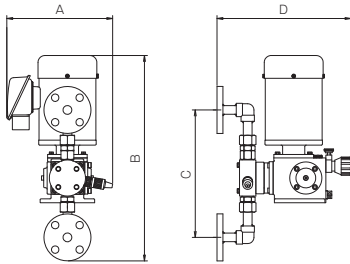

	A	B	C	D
003	214	415	257.5	270.5
006-01	214	415	257.5	272.5
02	214	415	257.5	274
03	214	415	257.5	276
06	185	419.5	266.5	277
1	185	427	282	289
2	185	427	282	291
3	185	407.5	350	299
4	185	407.5	350	301

* The dimensions displayed here are for the SUS flange connection type.
 * For further information about FXW and FYW, contact TACMINA.

FYD

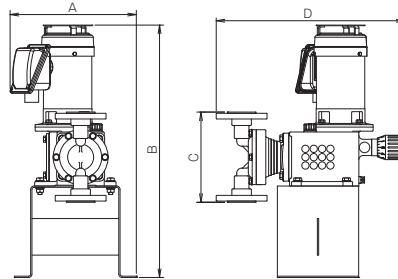

	A	B	C	D
3P	311	621	222	464.5
6	311	621	254	464.5
8	311	621	254	466.5
10	311	621	300	522
10P	350	702	300	587
15	350	702	300	587
20	350	702	300	592
20P	362	745	300	592
30	362	745	375	637.5

* The dimensions displayed here are for the SUS flange connection type.

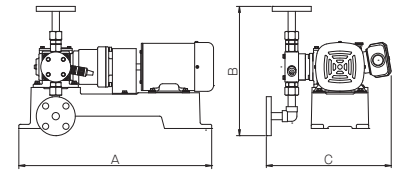

	A	B	C
003	470	315	300.5
006	470	315	300.5
01	470	315	300.5
03	470	315	302
06	470	324	303
1	470	340	315
2	470	340	315
4	470	412.5	325

* The dimensions displayed here are for the SUS flange connection type.

Hydraulic Diaphragm type

FXM

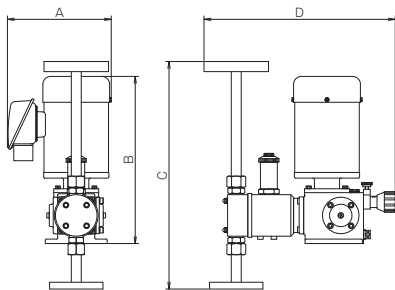

	A	B	C	D
01-02	185	297.5	405	340.5
06	185	297.5	421	327.5

* The dimensions displayed here are for the SUS flange connection type.
 * For FXMW•FYMW, please contact us.

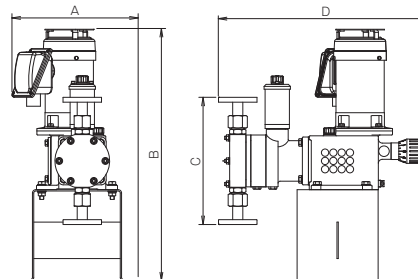

	A	B	C	D
08	311	621	314	513
08P	311	621	314	523
1	311	621	278	513
1P	311	621	340	523
3	311	621	278	515.5

* The dimensions displayed here are for the SUS flange connection type.

● Front view: Common

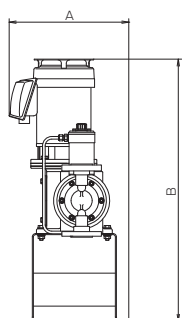

● Side view: 3P/6/6P

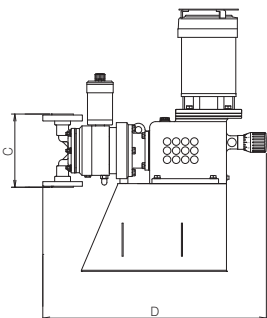

● Side view: 10/10P

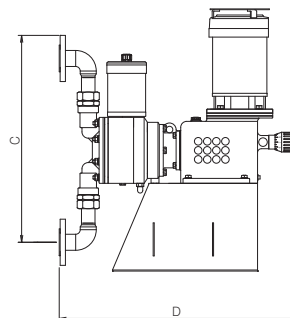

	A	B	C	D
3P	363	795	222	678
6-6P	363	795	262	683
10-10P	363	795	595	722

* The dimensions displayed here are for the SUS flange connection type.

● FYM

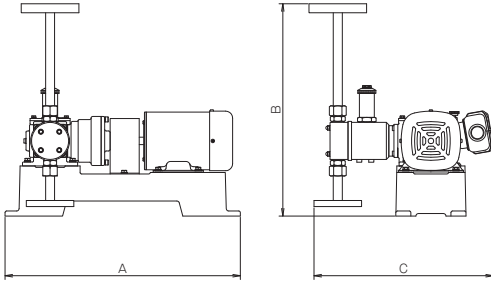

	A	B	C
01-02	470	424	364.5
06	470	432	351.5

* The dimensions displayed here are for the SUS flange connection type.

Plunger type

● FXP

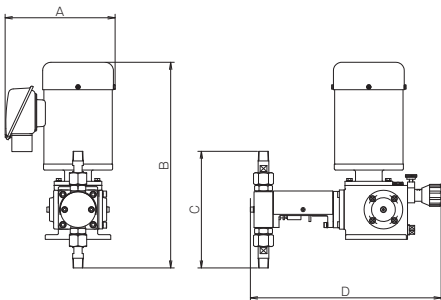

	A	B	C	D
0005	185	345.5	196	320.5
001	185	346.5	198	320.5
002	185	345.5	196	320.5
006	185	345.5	196	320.5
01	185	350.5	206	320.5
02	185	350.5	206	320.5

* The dimensions displayed here are for the union connection type.

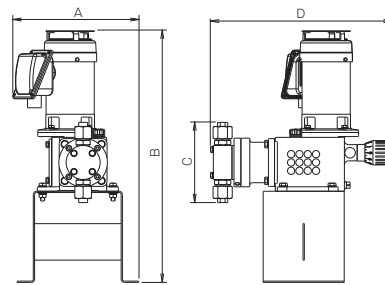

	A	B	C	D
04	311	621	198	449
08	311	621	198	449
08P	350	702	198	514
1	311	621	330	476.5
1P	350	702	302	518
3	311	621	268	469

* The dimensions displayed here are for the union connection type.

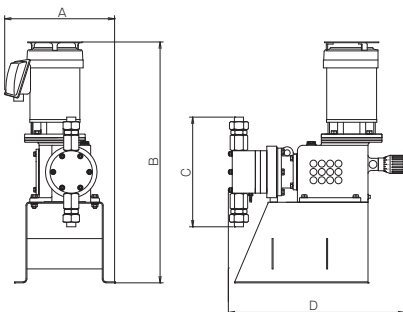

	A	B	C	D
3P	363	795	362	582
6P	363	795	316	624
10P	363	795	344	632

* The dimensions displayed here are for the union connection type.

● FYP

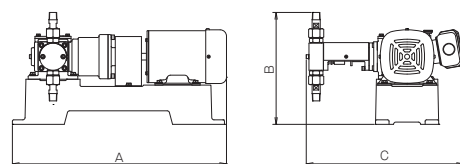

	A	B	C
0005	474.5	248	344
001	474.5	249	344
002	474.5	248	344
006	474.5	248	344
01	474.5	253	347
02	474.5	253	347

* The dimensions displayed here are for the union connection type.

Options, Application Products, and Related Products

For improved safety, accuracy, and simplicity. Options with excellent functionality.

We offer optional products suited to various sites to meet a wide range of needs.

[Valves]

Relief valve

Automatically releases the pressure when excessive pressure is produced in the pump's discharge-side piping due to clogging by foreign objects or a closed valve.



Back pressure valve

Prevents siphoning (where the liquid naturally flows) caused by the piping conditions.



[Sensor]

Pulse sensor

Uses a reed switch to detect the number of pump strokes as a pulse signal. Can be used to create an automatic measured injection system in combination with a pulse counter.



Leak monitor

When the diaphragm accidentally breaks, the electrode in the buffer fluid promptly detects and notifies the operator of a problem.



[Motor]

- Explosion proofing (explosion-proof, with increased safety; pressure-resistant and explosion-proof)
- Insulation (heat resistance)
- Varying voltage support
- IP enclosure rating
- AC servo motor, etc

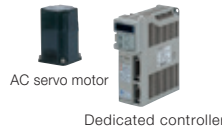

[Control unit]

Inverter (frequency control method)

Performs variable speed control of all models of motors at low cost.



» Please visit our website for other products.

Application products that can be used according to conditions and applications.

We offer a rich lineup of products that can be matched to the properties of liquids such as viscosity, percentage of contained slurry, and liquid temperature, as well as conditions such as injection accuracy and safety.

Sanitary specification

- Hygienic wetted part construction without seal components.
- Capable of gentle metered transfers without changing the properties of liquids.



Slurry liquid specification (T-branch remote head)

- T-branch system where the diaphragm does not directly touch sedimentary slurries.
- Simultaneously solves the problems of diaphragm service life and slurry clogging.



High-temperature fluid specification (T-branch remote head)

- A remote head type which does not transmit heat to the pump itself, making it capable of transferring high-temperature fluids that exceed 100°C.
- Can be equipped with heat-radiation fins and a heat-insulating jacket.



» Please refer to our catalogs for details on application products.

Introducing Smoothflow diaphragm pumps with no pulsation.

Smoothflow pump APL series

- Capable of transfers up to a maximum 20,000 mPa·s.
- Efficiently transfers high-viscosity fluids with an ideal design that holds down dead space.



Smoothflow pump BPL series

- Simple construction and excellent cost performance.
- For chemical injection/transfer applications at 0.05 L/min to 80 L/min.



Smoothflow pump XPL series Small capacity injection specification

- For R&D and high-mix low-volume processes.
- For injecting minute quantities of chemicals.



Recommended Piping Example

In order to fully demonstrate the capabilities of metering pumps (metering performance, discharge accuracy), the correct piping design and auxiliary equipment must be installed. Appropriate piping design also helps to prevent piping and pump accidents and problems, and promises safety and peace of mind for production lines. The recommended piping for each pump mechanism will fully draw out the capabilities of the metering pump.

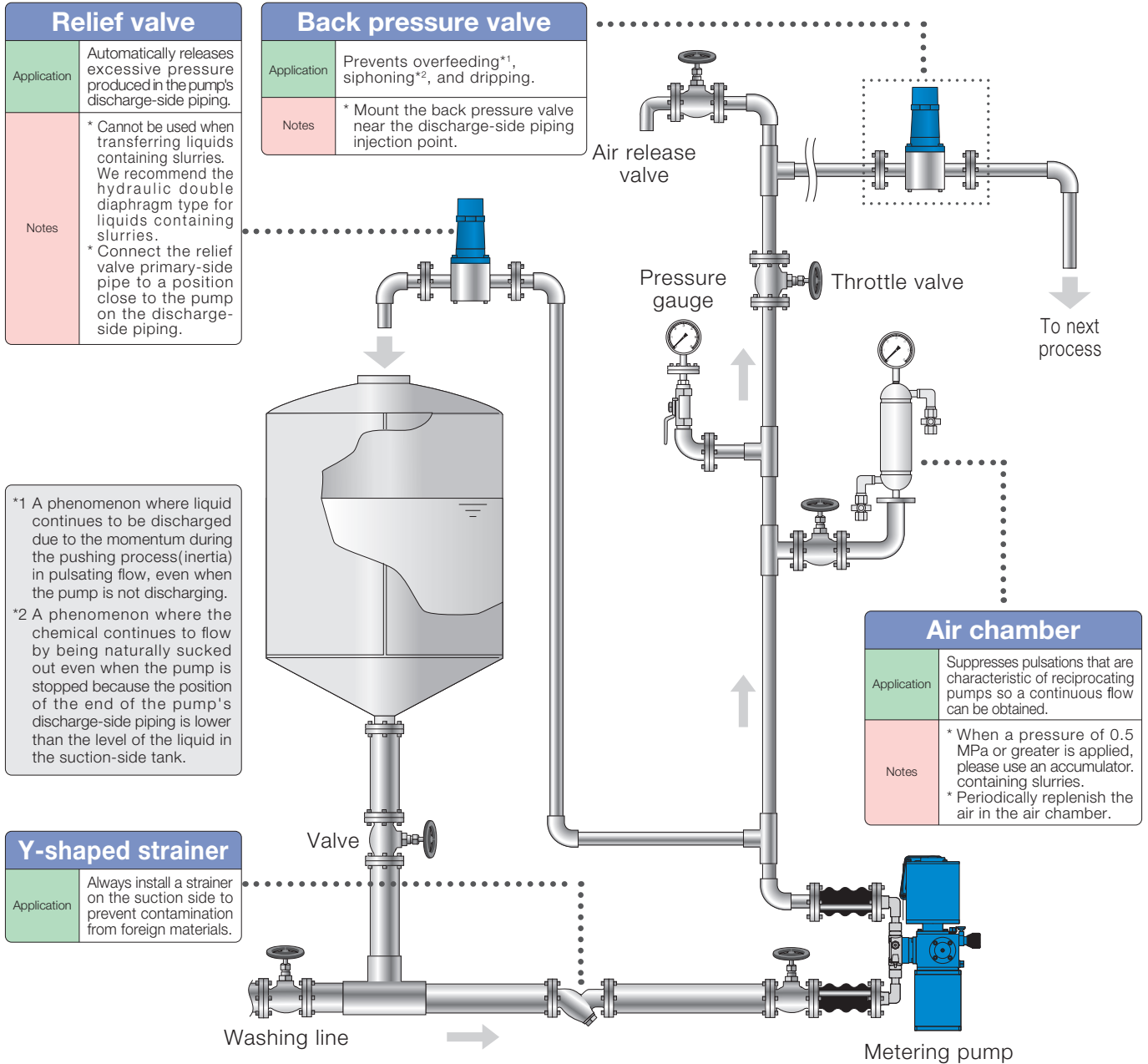

Introducing Smoothflow diaphragm pumps with no pulsation.

Point 1

Install an air release pipe on the suction side if necessary. (Example: Liquids that easily vaporize or that produce gas such as sodium hypochlorite).

Point 2

If the length of the discharge-side piping becomes long, always use an air chamber or accumulator.³ If the length of the piping becomes long, the pipe resistance will increase and abnormal pressure will be generated, which may damage the diaphragm or eccentric shaft.

Point 3

Always install a relief valve on the discharge-side piping. This prevents abnormal pressure from bursting the air chamber or damaging the pump.

Point 4

In order to prevent piping accidents, select a pipe size for the piping in the discharge and suction areas, as well as the relief valve and back pressure valve, that is equal to or larger than the pump diameter.

Point 5

Design the process so that the pump suction-side piping is short and simple.

* The above diagram is one example of piping. For more details, contact your sales representative.

* The hydraulic double diaphragm type is suited to high-accuracy transfer and injection of liquids containing slurries and highly viscous fluids. For detailed piping designs, please contact us.

* Install valves before and after each device for maintenance and inspection purposes.

*³ Problems related to pulsations are resolved by using Smoothflow pumps. For details, please contact a sales representative or refer to the "Smoothflow Pump Catalog".

TACMINA CORPORATION

Head Office:

2-2-14 Awajimachi, Chuo-ku, Osaka 541-0047 Japan
Tel.+81(0)6-6208-3974 Fax.+81(0)6-6208-3978
URL www.tacmina.com
E-mail trade@tacmina.com

Product designs and specifications are subject to change without notice for product improvement.

EC-060 (8)-

2020/6/S--



JQA-A-1274
JQA-EMISSI Production Department